

Article number: 12308200080110

Description: KLEE-coil 308 200 080.110

M8 Hardened/zinc-plated steel with hexagon

Measures

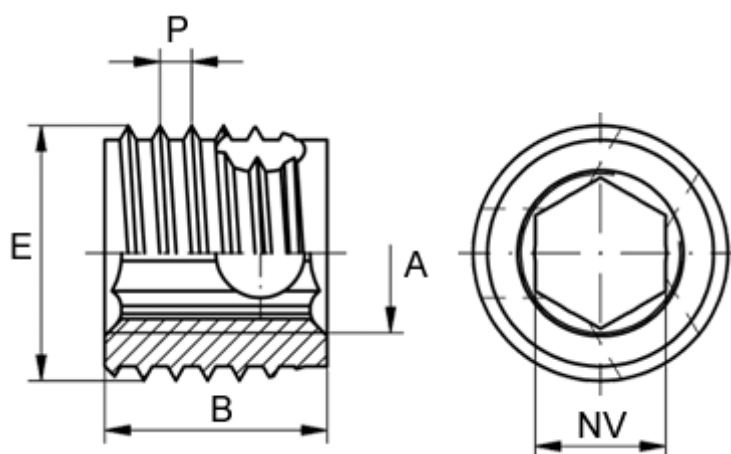

Female thread A	= M8
Length B	= 14
Male thread E	= 12
Min hole depth blind hole	= 17
Min material thickness	= 14
sw	= -
Thread pitch P	= 1.5
Type	= 308 200 080 ...